

Selection diagram

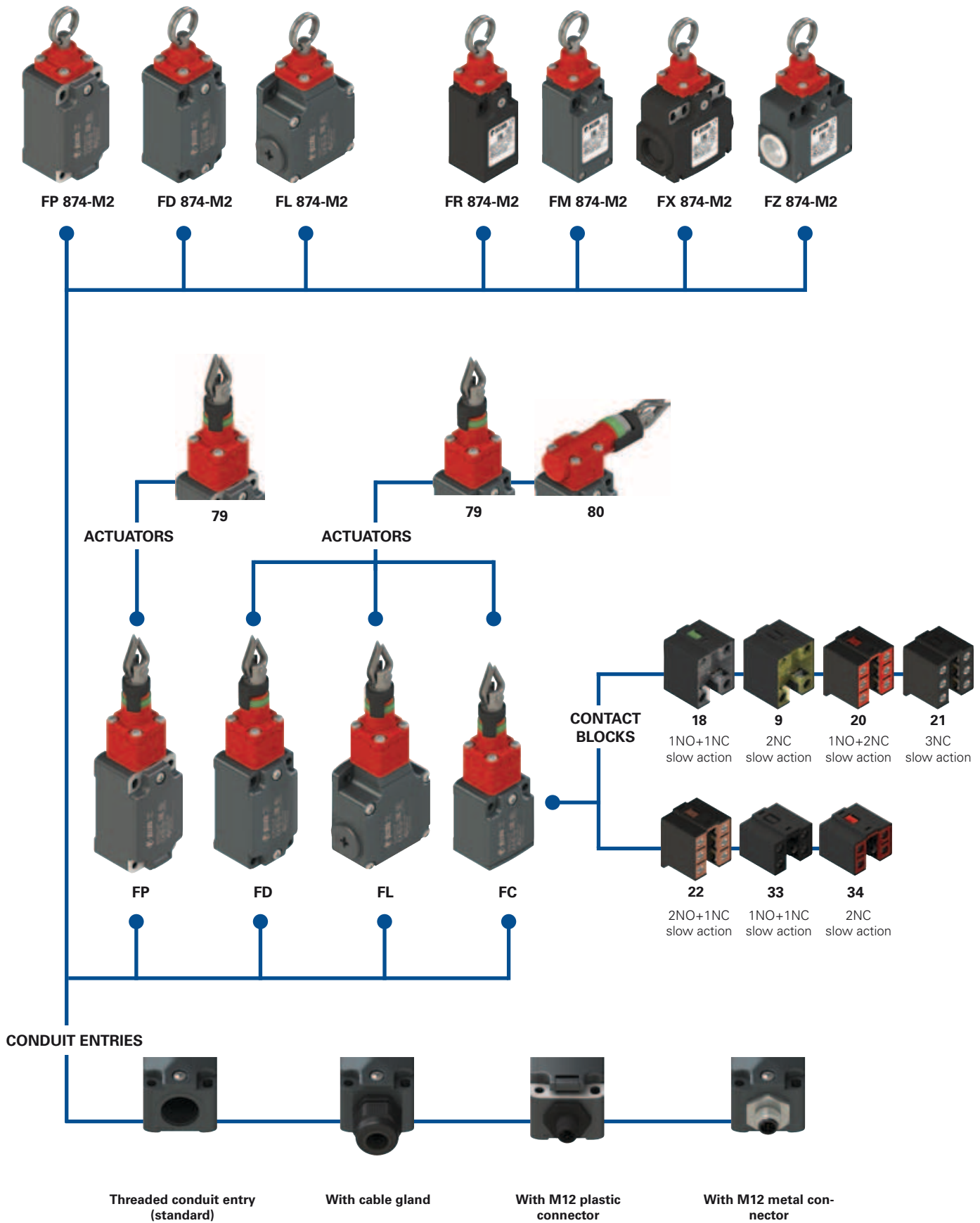

—●— product option



Code structure

Attention! The feasibility of a code number does not mean the effective availability of a product. Please contact our sales office.

article options options
FD 1879-E7GM2K50T6

Housing

FD	metal, one conduit entry
FL	metal, three conduit entries
FP	technopolymer, one conduit entry

Contact block

18	1NO+1NC, slow action
9	2NC, slow action
20	1NO+2NC, slow action
21	3NC, slow action
22	2NO+1NC, slow action
33	1NO+1NC, slow action
34	2NC, slow action

Actuating head

79	longitudinal head
80	transversal head (FD-FL housing only)

Actuating force

	standard
E7	initial 20 N...final 40 N (only head 79)
E9	initial 13 N...final 75 N (only head 80)

Ambient temperature

	-25°C ... +80°C (standard)
T6	-40°C ... +80°C

Pre-installed cable glands or connectors

	no cable gland or connector (standard)
K23	cable gland for cables Ø 6 ... 12 mm
...
K50	M12 metal connector, 5-pole
...

For the complete list of possible combinations please contact our technical department.

Threaded conduit entry

M2	M20x1.5 (standard)
	PG 13.5

Contact type

	silver contacts (standard)
G	silver contacts with 1 µm gold coating
G1	Silver contacts, 2.5 µm gold coating (not for contact blocks 20, 21, 22, 33, 34)

article options options
FC 3379-E7GM2K50T6

Housing

FC	metal, one conduit entry
-----------	--------------------------

Contact block

33	1NO+1NC, slow action
34	2NC, slow action

Actuating head

79	longitudinal head
80	transversal head

Actuating force

	standard
E7	initial 20 N...final 40 N (only head 79)
E9	initial 13 N...final 75 N (only head 80)

Pre-installed cable glands

	no cable gland (standard)
K23	cable gland for cables Ø 6 ... 12 mm
K50	M12 metal connector, 5-pole

Threaded conduit entry

M2	M20x1.5 (standard)
	PG 11

Ambient temperature

	-25°C ... +80°C (standard)
T6	-40°C ... +80°C

Contact type

	silver contacts (standard)
G	silver contacts with 1 µm gold coating

article options options
FD 874-E7GM2K50T6

Housing

FD	metal, one conduit entry
FL	metal, three conduit entries
FP	technopolymer, one conduit entry
FR	technopolymer, one conduit entry
FM	metal, one conduit entry
FX	technopolymer, two conduit entries
FZ	metal, two conduit entries

Actuating force

	standard
E7	initial 20 N...final 40 N

Pre-installed cable glands or connectors

	no cable gland or connector (standard)
K23	cable gland for cables Ø 6 ... 12 mm
...
K50	M12 metal connector, 5-pole
...

For the complete list of possible combinations please contact our technical department.

Threaded conduit entry

M2	M20x1.5 (standard)
M1	M16x1.5 (FR-FX housing only)
	PG 13.5
A	PG 11 (FR-FX housing only)

Ambient temperature

	-25°C ... +80°C (standard)
T6	-40°C ... +80°C

Contact type

	silver contacts (standard)
G	silver contacts with 1 µm gold coating
G1	silver contacts with 2.5 µm gold coating



Main features

- Metal or plastic housing, from one to three conduit entries
- Protection degree IP67
- 7 contact blocks available
- Versions with vertical or horizontal actuation
- Versions with assembled M12 connector
- Versions with gold-plated silver contacts

Quality marks:



IMQ approval:	EG605 (FD-FLFP-FC series) EG610 (FR-FX series) EG609 (FM-FZ series)
UL approval:	E131787
CCC approval:	2007010305230000 (FD-FL-FC series) 2007010305230014 (FP series) 2007010305230013 (FR-FX series) 2007010305229998 (FM-FZ series)
EAC approval:	RU C-IT.AД35.B.00454

Technical data

Housing

FP, FR, FX series housing made of glass fibre reinforced technopolymer, self-extinguishing, shock-proof and with double insulation: \square

FD, FL, FC, FM, FZ series: metal housing, baked powder coating.

FD, FP, FC, FR, FM series: one threaded conduit entry: M20x1.5 (standard)

FX series: two knock-out threaded conduit entries: M20x1.5 (standard)

FZ series: two threaded conduit entries: M20x1.5 (standard)

FL series: three threaded conduit entries: M20x1.5 (standard)

Protection degree: IP67 acc. to EN 60529 with cable gland of equal or higher protection degree

General data

For safety applications up to: SIL 3 acc. to EN 62061
PL e acc. to EN ISO 13849-1

Safety parameters:

B_{100} : 2,000,000 for NC contacts

Service life: 20 years

Ambient temperature: -25°C ... +80°C

Max. actuation frequency: 1 cycle / 6 s

Mechanical endurance: 1 million operating cycles

Max. actuation speed: 0.5 m/s

Min. actuation speed: 1 mm/s

Tightening torques for installation: see page 313-324

Cable cross section (flexible copper strands)

Contact blocks 20, 21, 22, 33, 34: min. 1 x 0.34 mm² (1 x AWG 22)
max. 2 x 1.5 mm² (2 x AWG 16)

Contact blocks 18, 8, 9: min. 1 x 0.5 mm² (1 x AWG 20)
max. 2 x 2.5 mm² (2 x AWG 14)

In compliance with standards:

IEC 60947-5-1, EN 60947-5-1, EN 60947-1, IEC 60204-1, EN 60204-1, EN ISO 14119, EN ISO 12100, IEC 60529, EN 60529, UL 508, CSA 22.2 No.14 .

Approvals:

IEC 60947-5-1, UL 508, CSA 22.2 No.14, GB14048.5-2001.

Compliance with the requirements of:

Low Voltage Directive 2014/35/EU, EMC Directive 2014/30/EU.

Positive contact opening in conformity with standards:

IEC 60947-5-1, EN 60947-5-1.

⚠ If not expressly indicated in this chapter, for correct installation and utilization of all articles see chapter utilization requirements from page 313 to page 324.

	Electrical data	Utilization category
without connector	Thermal current (I_{th}):	10 A
	Rated insulation voltage (U_r):	500 Vac 600 Vdc 400 Vac 500 Vdc (contact blocks 20, 21, 22, 33, 34)
	Rated impulse withstand voltage (U_{imp}):	6 kV 4 kV (contact blocks 20, 21, 22, 33, 34)
	Conditional short circuit current: Protection against short circuits: Pollution degree:	1000 A acc. to EN 60947-5-1 type aM fuse 10 A 500 V 3
with M12 connector 4 and 5-pole	Thermal current (I_{th}):	4 A
	Rated insulation voltage (U_r):	250 Vac 300 Vdc
	Protection against short circuits: Pollution degree:	type gG fuse 4 A 500 V 3
		Alternating current: AC15 (50÷60 Hz) U_e (V) 24 120 250 I_e (A) 4 4 4 Direct current: DC13 U_e (V) 24 125 250 I_e (A) 4 1.1 0.4
with M12 connector 8-pole	Thermal current (I_{th}):	2 A
	Rated insulation voltage (U_r):	30 Vac 36 Vdc
	Protection against short circuits: Pollution degree:	type gG fuse 2 A 500 V 3
		Alternating current: AC15 (50÷60 Hz) U_e (V) 24 I_e (A) 2 Direct current: DC13 U_e (V) 24 I_e (A) 2



Description



These rope-operated safety switches are installed on machines or conveyor belts and facilitate the simple shut-down of the machine from any point and with any pull on the rope.

Provided with **self-control function**, they allow the constant monitoring of correct functioning, signalling with the opening of the contacts an eventual loosening or breaking of the rope.

Head with variable orientation

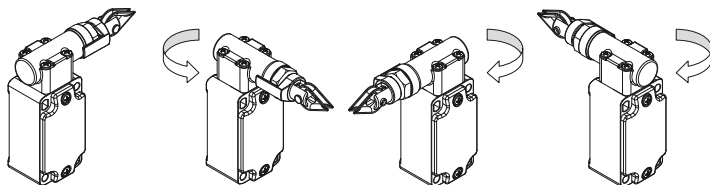

For all switches, the head can be adjusted in 90° steps after removing the four fastening screws.

Protection degree IP67

IP67 These devices are designed to be used in the toughest environmental conditions and they pass the IP67 immersion test acc. to EN 60529. They can therefore be used in all environments where maximum protection degree of the housing is required.

Extended temperature range

-40°C These devices are also available in a special version suitable for an ambient operating temperature range from -40°C up to +80°C.

They can therefore be used for applications in cold stores, sterilisers and other equipment with low temperature environments. The special materials used to produce these versions retain their characteristics even under these conditions, thereby expanding the installation possibilities.

Indicator for rope adjustment

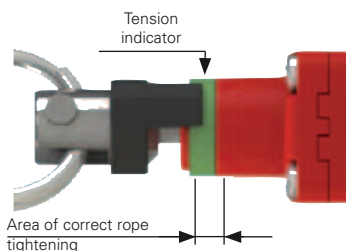

The switches (head 79 and 80) are provided with a green ring that shows the area of the correct tightening of the rope. The installer has only to tighten the rope until the black indicator will be in the middle of the green area. If the tension (or loosening) on the rope is so high that the black indicator exits the green area, the

electrical safety contacts will open.

Actuating forces

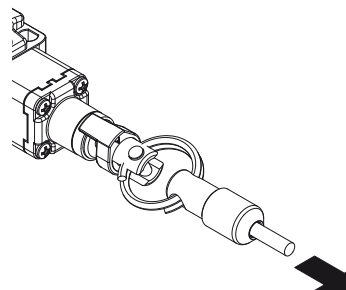

These switches can be supplied with reduced hardness internal springs on request. The force required to actuate the switch can thereby be reduced without changing the actuating path of the electrical contacts. This is particularly advantageous for smaller spans, but must, however, always make use of rope pulleys.

Features approved by IMQ

Rated insulation voltage (U _i):	500 Vac 400 Vac (for contact blocks 20, 21, 22, 33, 34)
Conventional free air thermal current (I _{th}):	10 A
Protection against short circuits:	type aM fuse 10 A 500 V
Rated impulse withstand voltage (U _{imp}):	6 kV 4 kV (for contact blocks 20, 21, 22, 33, 34)
Protection degree of the housing:	IP67
MV terminals (screw terminals)	
Pollution degree:	3
Utilization category:	AC15
Operating voltage (U _e):	400 Vac (50 Hz)
Operating current (I _a):	3 A

Forms of the contact element: Zb, Y+Y, Y+Y+X, Y+Y+Y, Y+X+X
Positive opening contacts on contact blocks 18, 8, 9, 20, 21, 22, 33, 34
In compliance with standards: EN 60947-1, EN 60947-5-1 + A1:2009, fundamental requirements of the Low Voltage Directive 2014/35/EU.

Please contact our technical department for the list of approved products.

Features approved by UL

Utilization categories	Q300 (69 VA, 125-250 Vdc) A600 (720 VA, 120-600 Vac)
Housing features type 1, 4X "indoor use only";	12, 13
For all contact blocks use 60 or 75 °C copper (Cu) conductor, rigid or flexible,	wire size 12, 14 AWG. Tightening torque for terminal screws of 7.1 lb in (0.8 Nm).

In compliance with standard: UL 508, CSA 22.2 No.14

Please contact our technical department for the list of approved products.

Dimensional drawings

All values in the drawings are in mm

Contact type:
L = slow action

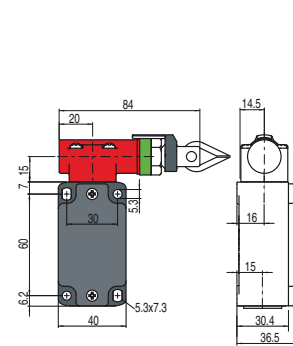
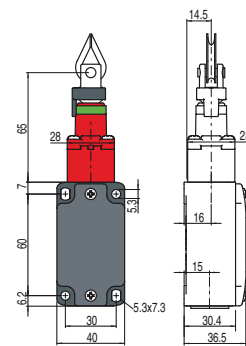
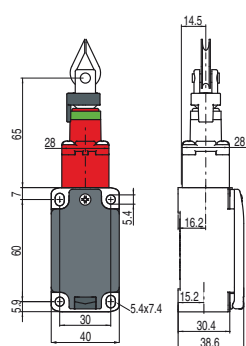

Contact block

18	L	FP 1879-M2	⊕	1NO+1NC		FD 1879-M2	⊕	1NO+1NC	FD 1880-M2	⊕	1NO+1NC
9	L	FP 979-M2	⊕	2NC		FD 979-M2	⊕	2NC	FD 980-M2	⊕	2NC
20	L	FP 2079-M2	⊕	1NO+2NC		FD 2079-M2	⊕	1NO+2NC	FD 2080-M2	⊕	1NO+2NC
21	L	FP 2179-M2	⊕	3NC		FD 2179-M2	⊕	3NC	FD 2180-M2	⊕	3NC
22	L	FP 2279-M2	⊕	2NO+1NC		FD 2279-M2	⊕	2NO+1NC	FD 2280-M2	⊕	2NO+1NC
33	L	FP 3379-M2	⊕	1NO+1NC		FD 3379-M2	⊕	1NO+1NC	FD 3380-M2	⊕	1NO+1NC
34	L	FP 3479-M2	⊕	2NC		FD 3479-M2	⊕	2NC	FD 3480-M2	⊕	2NC
Actuating force		Initial 63 N...final 83 N (90 N ⊕)				Initial 63 N...final 83 N (90 N ⊕)			Initial 147 N...final 235 N (250 N ⊕)		
Travel diagrams		page 182 - group 1				page 182 - group 1			page 182 - group 2		

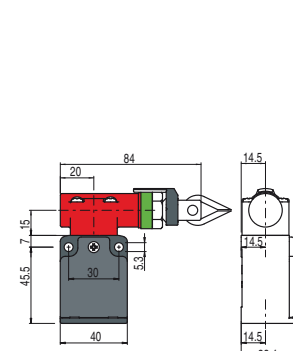
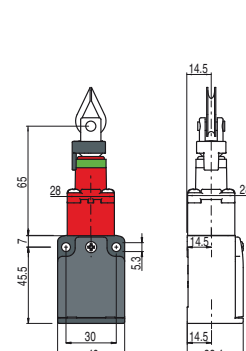
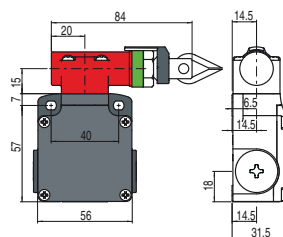
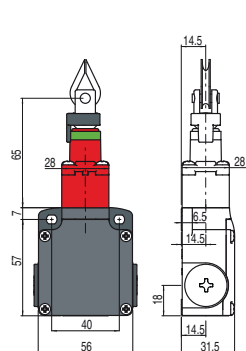

Contact block

18	L	FL 1879-M2	⊕	1NO+1NC	FL 1880-M2	⊕	1NO+1NC						
9	L	FL 979-M2	⊕	2NC	FL 980-M2	⊕	2NC						
20	L	FL 2079-M2	⊕	1NO+2NC	FL 2080-M2	⊕	1NO+2NC						
21	L	FL 2179-M2	⊕	3NC	FL 2180-M2	⊕	3NC						
22	L	FL 2279-M2	⊕	2NO+1NC	FL 2280-M2	⊕	2NO+1NC						
33	L	FL 3379-M2	⊕	1NO+1NC	FL 3380-M2	⊕	1NO+1NC	FC 3379-M2	⊕	1NO+1NC	FC 3380-M2	⊕	1NO+1NC
34	L	FL 3479-M2	⊕	2NC	FL 3480-M2	⊕	2NC	FC 3479-M2	⊕	2NC	FC 3480-M2	⊕	2NC
Actuating force		Initial 63 N...final 83 N (90 N ⊕)			Initial 147 N...final 235 N (250 N ⊕)			Initial 63 N...final 83 N (90 N ⊕)			Initial 147 N...final 235 N (250 N ⊕)		
Travel diagrams		page 182 - group 1			page 182 - group 2			page 182 - group 1			page 182 - group 2		

How to read travel diagrams

All values in the diagrams are in mm

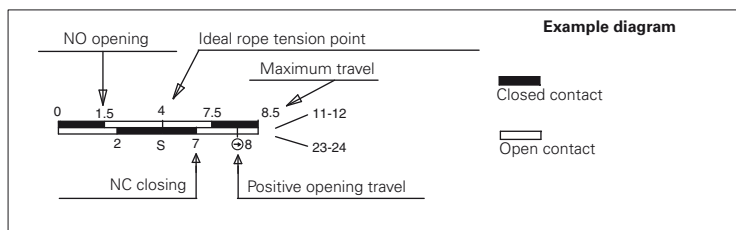

IMPORTANT:

In **safety applications**, actuate the switch **at least up to the positive opening travel** shown in the travel diagrams with symbol ⊕. Actuate the switch **at least with the positive opening force**, reported in brackets below each article, next to the actuating force value.

Items with code on **green** background are stock items

Accessories See page 299

→ The 2D and 3D files are available at www.pizzato.com



Contact type:

L = slow action

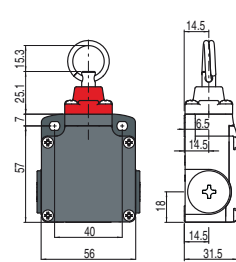
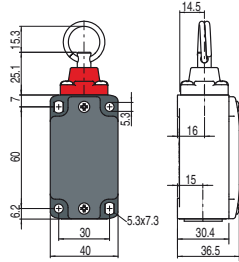
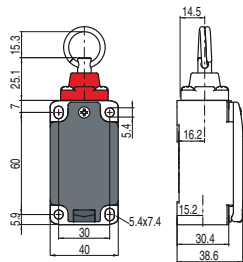

Contact block

8 L	FP 874-M2 1NC	FD 874-M2 1NC	FL 874-M2 1NC
Actuating force	Initial 63 N...final 83 N (90 N)	Initial 63 N...final 83 N (90 N)	Initial 63 N...final 83 N (90 N)
Travel diagrams	page 182 - group 3	page 182 - group 3	page 182 - group 3

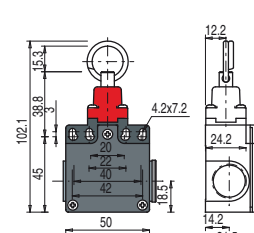
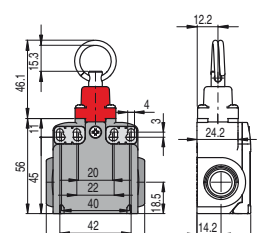
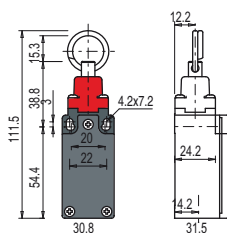
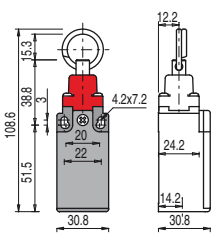

Contact block

8 L	FR 874-M2 1NC	FM 874-M2 1NC	FX 874-M2 1NC	FZ 874-M2 1NC
Actuating force	Initial 63 N...final 83 N (90 N)	Initial 63 N...final 83 N (90 N)	Initial 63 N...final 83 N (90 N)	Initial 63 N...final 83 N (90 N)
Travel diagrams	page 182 - group 3	page 182 - group 3	page 182 - group 3	page 182 - group 3

Travel diagrams table

Contact block	Group 1	Group 2	Group 3
18 1NO+1NC			
8 1NC			
9 2NC			
20 1NO+2NC			
21 3NC			
22 2NO+1NC			
33 1NC+1NO			
34 2NC			

In the rest position (with rope correctly tightened) the two contacts of **contact block 8** are both closed and are activated respectively by tightening or loosening the rope. In order to use this contact block for safety applications it is necessary to connect the two contacts in series. For this reason, in the wiring diagrams the **contact block 8** is indicated as 1NC, whereas in travel diagrams both contacts are indicated.

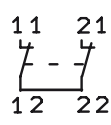

Accessories See page 299

→ The 2D and 3D files are available at www.pizzato.com

Application examples and max. rope length for switches with longitudinal head

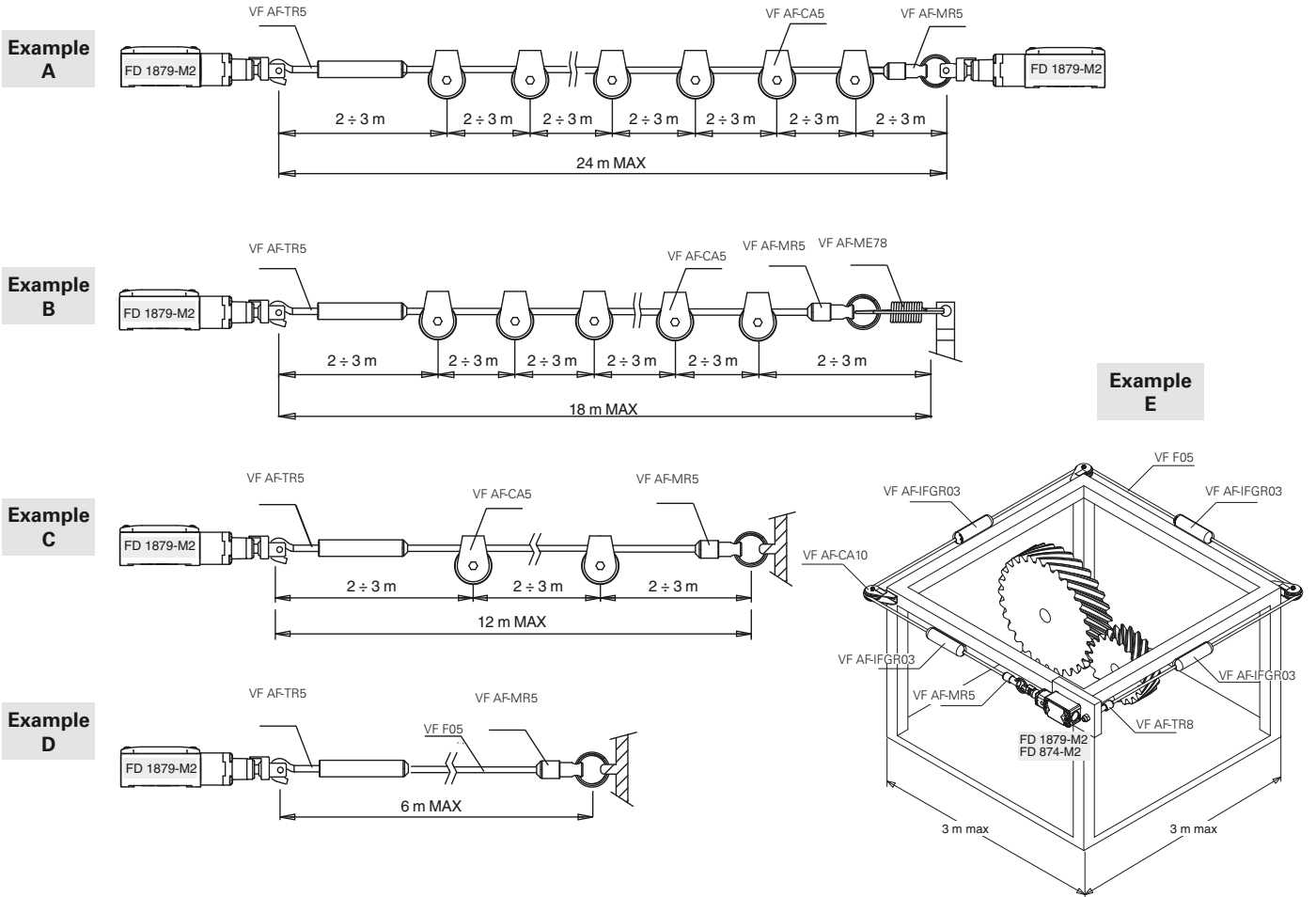

Application examples and max. rope length for switches with transversal head

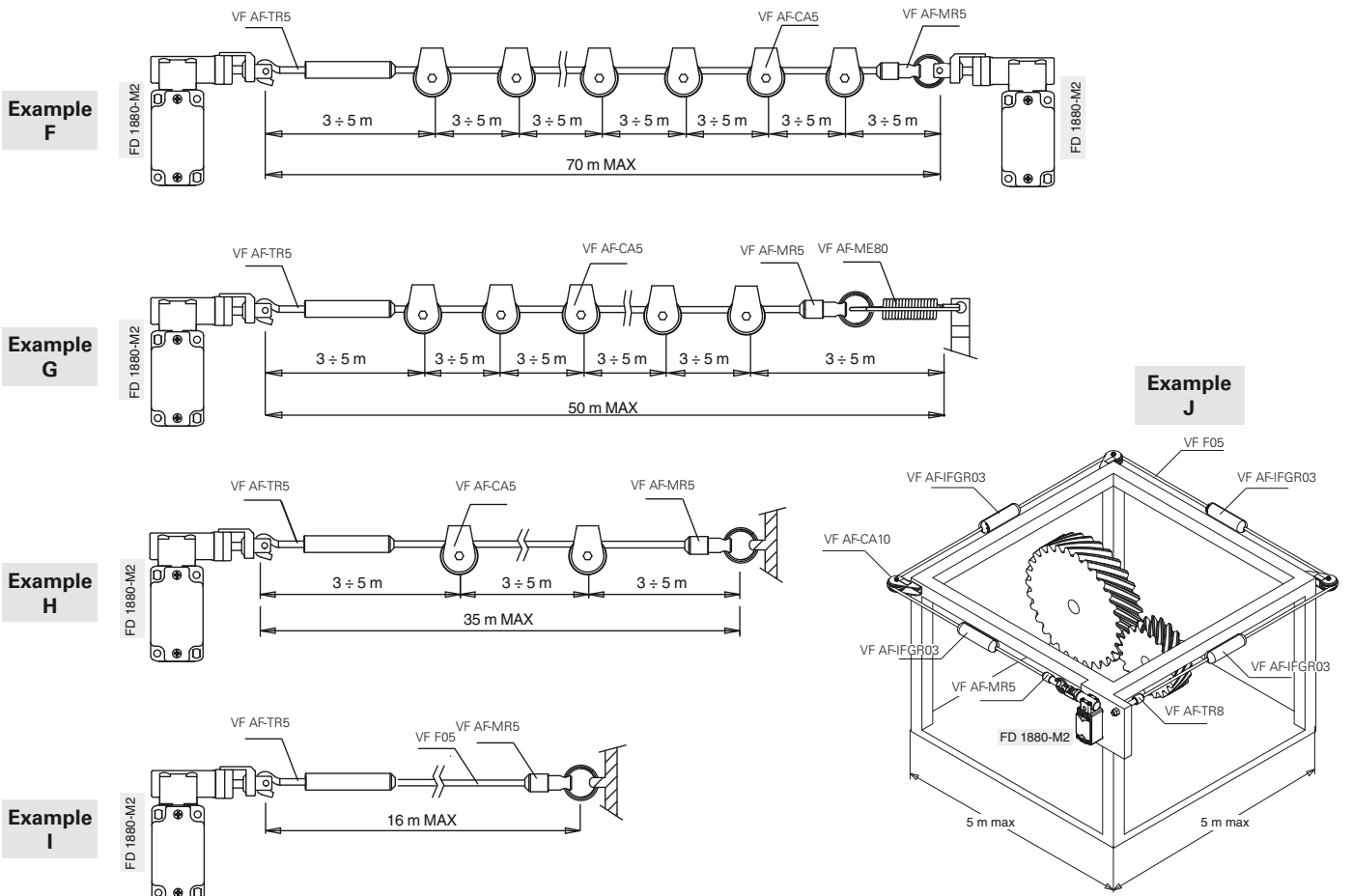

Maximum spans

Maximum spans for switches with longitudinal head

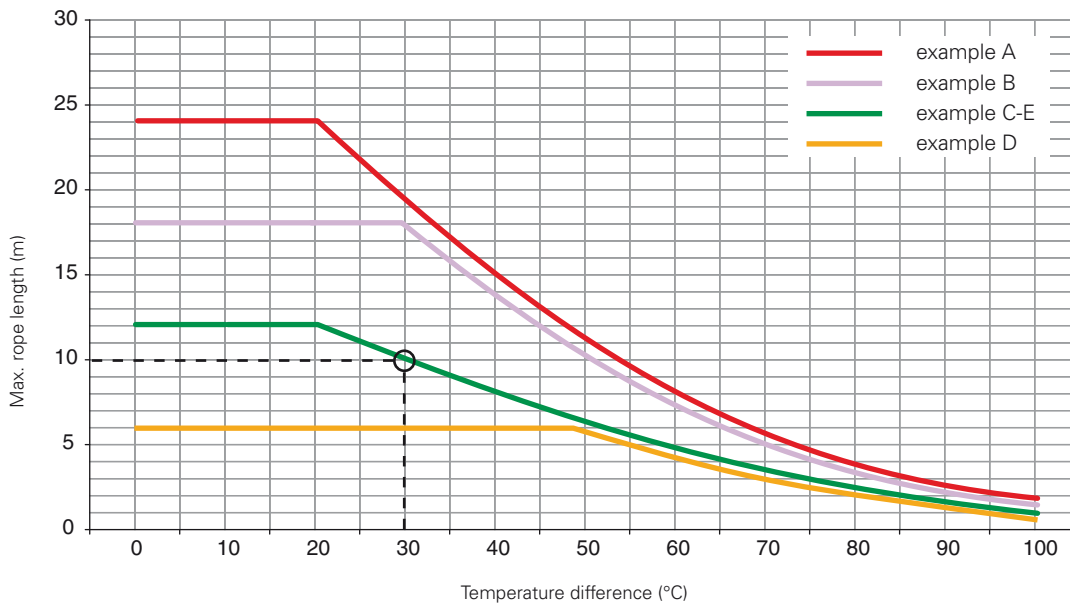

The max. recommended spans are indicated in the diagram as a function of the temperature fluctuations (temperature differences) to which the switch may be exposed at the point of use. For instance, with installation of type C and a temperature difference of 30°C, the max. recommended rope length is 10 metres.

Maximum spans for switches with transversal head

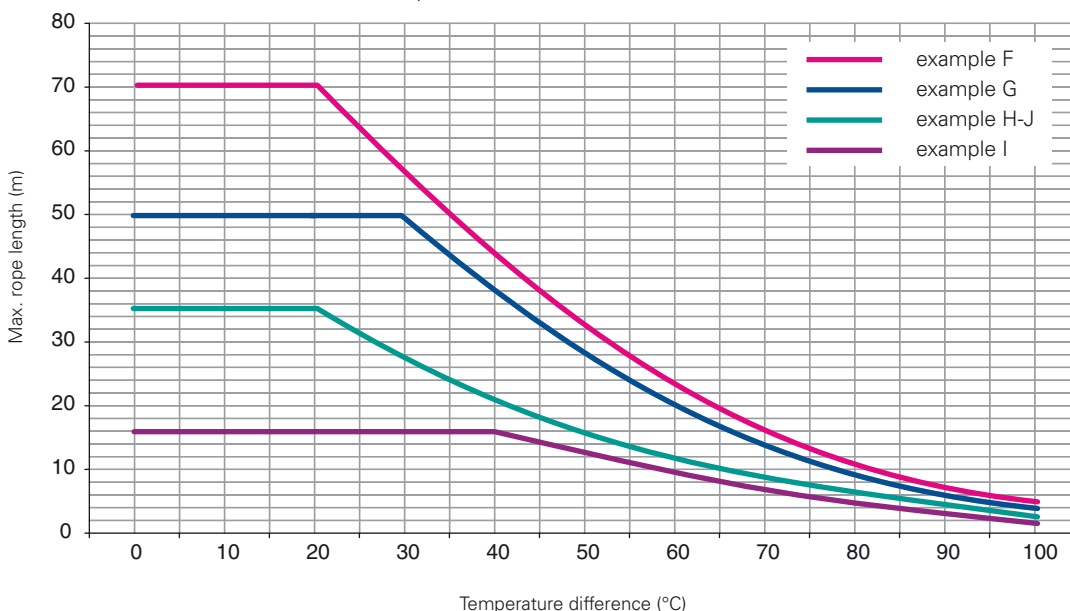

Important: The above data are guaranteed only using original rope and accessories. See page 185.

Adjustment of the switching point

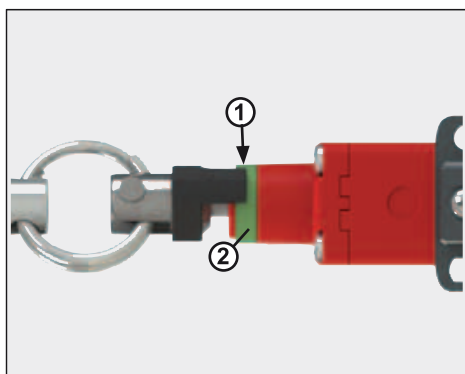

For switches with head 79 and 80: Tighten the rope connected to the switch, until the end of the indicator (1) reaches about the middle of the green ring (2).

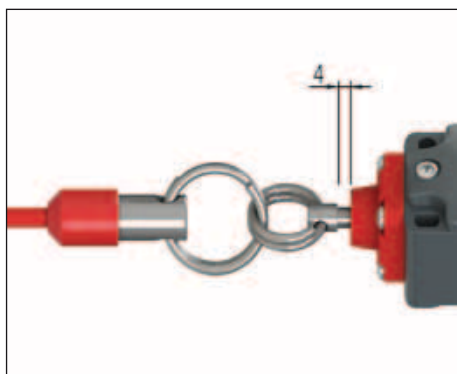

For switches with head 74: Tighten the rope connected to the switch until the thimble will be at about 4 mm from the head.